



## BONGO 3 (REMOTE)

1 Light Sources

3" | 1929 lm / per light source  
Round | Fixed | Surface Mounted

Performance Options	9W	13W	18W	26W
Source Lumens	1158 lm	1524 lm	2032 lm	Im
Delivered Lumens	708 lm	1181 lm	1575 lm	1929 lm
Lumens / Watt	79 lm	91 lm	88 lm	74 lm
Current	250 mA	350 mA	500 mA	700 mA
CRI/CCT Multiplier	2700°K	3000°K	3500°K	4000°K
80 CRI	0.93	1.00	1.00	1.07
95 CRI	0.69	0.75	0.81	0.87

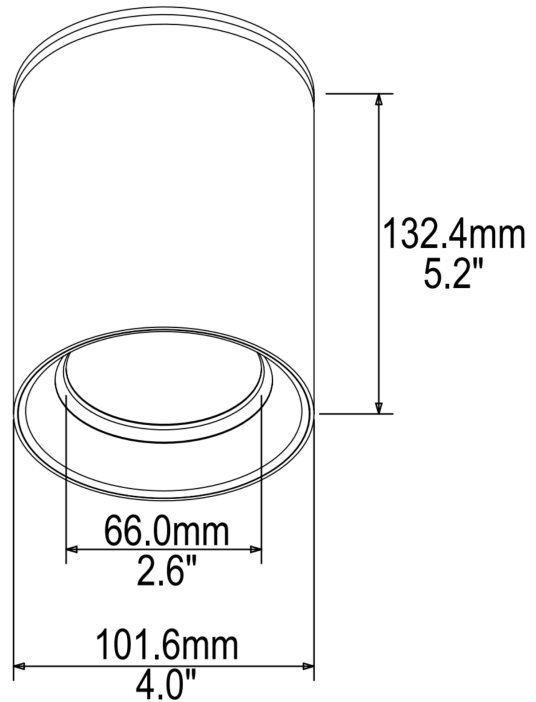

S3	BNG3R	—	—	—	—	—	—	—	—	—
Source	Model	Wattage	Kelvin	CRI	Beam	Lens	Color	Driver	Installation	I.P. Rating
S3	BNG3R:Bongo 3 (Remote)	09:09W 13:13W 18:18W	27:2700k 30:3000k 35:3500k 40:4000k WD:Warm Dim 1800K to 3000K (Not possible with 18W, Driver must be remote) RW:RGBW(Driver must be remote) TD:Tunable White 2700K to 6500K (Daylight) TH:Tunable White 1800K to 4000K (Hospitality)	A:80 B:95	6:60° 3:36° 2:24° 1:10°(WD, TH, TD, and RGBW not possible with 10°)	F:Frosted X:Hex Louver + Solite L:Cross Louver + Solite P:Prismatic S:Solite C:Clear	WS:Matte White BK:Matte Black WK:White Trim / Black Splay BP:Black Pearl SN:Satin Nickel BZ:Bronze CC:Custom Color	0:No Driver N:Non-Dimmable E:ELV Dimmable Z:0-10V Dimmable to 1% B:Bluetooth D:DALI X:DMX	M0:j-Box Cover (Beauty ring to cover 4.0" j-box opening. Driver is remote) R0:Retro-Fit Enclosure RL:Retro-Fit for Lutron™	D:Dry IP 20

Optional Emergency Backup Battery can be found on Products/[Accessories](#)

Generated on 05-06-2024

## Specifications

This specification Grade LED downlight offers a wide selection of LED modules options to address design requirements in the spaces it illuminates. Many additional custom options are available; please contact manufacturer for details.

### LED source

Tool-free field-replaced LED module. Proprietary high performance aluminum die cast heatsink for maximum LED life.

### Source

Computer-optimized reflector design. High reflected finish aluminum. Tool-free field-interchangeable reflectors and lens. 0-20°(O version), 0-40°(J version) vertical and 360° horizontal adjustment.

### Body

Die-cast aluminum frame and body.

### Trim

Die-cast aluminum CNC machine finished Minimal thickness. White can be field painted to match adjacent finishes.

### Fixture retention

Two torsion springs hold the fixture tight to the ceiling accommodating ceiling thickness from 1/16" to 1". Special springs for thicker ceiling available on request.

### Life

Rated for 50,000 hours at 70% lumen maintenance.

### Label

ETL listed for US Canada. CE labeled. CCC label available on request.

### Warranty

5 years limited warranty.

### Wet location

(if option is available and selected on page 1) Sealed lens and integral silicon gasket behind the trim.

## Dimming compatibility

Zaniboni fixture are compatible with all major dimming protocol in the industry. Please refer to [zanibonilighting.com](http://zanibonilighting.com) for general compatibility and wiring diagrams. Zaniboni recommends testing your unique dimming configuration as the exact full configuration (Dimmer, drivers, fixture quantities, voltage) may affect dimming performance.



### N: Non-Dimmable

110-277V, 50/60Hz.

Economic solution for ON-OFF applications not requiring dimming.



### E: ELV Dimmable

110-277V, 50/60Hz.

For ELV(Electronic Low Voltage) dimmers. Best for new construction application. Dims down to less than 10% light output(most cases). Consult dimming manufacturer for installation instructions. Must meet dimmer Minimum load Requirements.

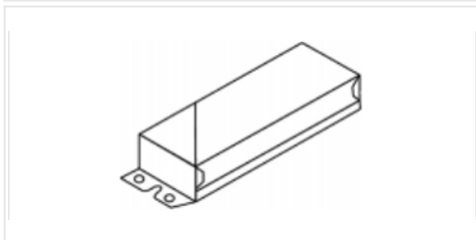

### Z: 0-10V Dimmable

110-277, 50/60Hz.

Prevalent solution on commercial projects. Integrates into a variety of building management and day lighting controls. Dims down to less than 1% light output(most cases). Must meet dimmer Minimum Load Requirements. Consult dimming manufacturer for installation instructions.

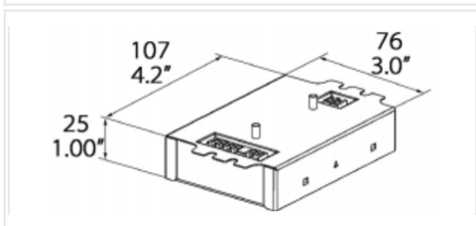

### L: Lutron Hi-Lume A LDE

120-277V, 50/60Hz.

For LUTRON EcoSystem drivers only. Continuous dimming to 1%

Consult dimming manufacturer for installation instructions. Requires access from above on all fixtures with a cutout below 81mm.

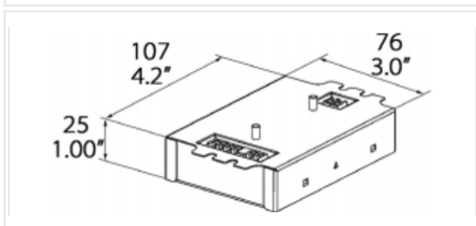

### T: Lutron Hi-Lume A LTE

120V, 50/60Hz.

For 2-wire Forward Phase Controls. Continuous dimming to 1%

Consult dimming manufacturer for installation instructions. Requires access from above on all fixtures with a cutout below 81mm.

**N&E:** Non-Dimmable & ELV Drivers

Measurements	LWH in mm	LWH in inches
7W - 9W - 13W	85.5 - 38 - 27.7	3.36" - 1.49" - 1.09"
18W - 26W	89 - 41 - 31.5	3.5" - 1.62" - 1.24"
36W - 50W	89 - 41 - 31.5	3.5" - 1.62" - 1.24"

**N&E:** Non-Dimmable, ELV Drivers & 0-10V Dimmable

Measurements	LWH in mm	LWH in inches
7W - 9W - 13W	85.3 - 38 - 27.7	3.36" - 1.49" - 1.09"
18W - 26W	89 - 41 - 31.5	3.5" - 1.62" - 1.24"
36W - 50W	138 - 47 - 32	5.43" - 1.85" - 1.25"

## Installation

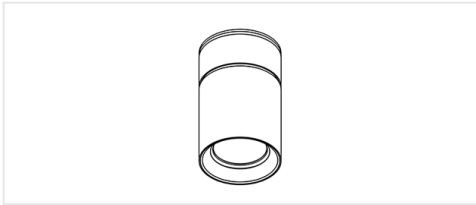

### **L: Canopy for On-Board Driver**

Canopy for on-board ELV or 0-10V driver

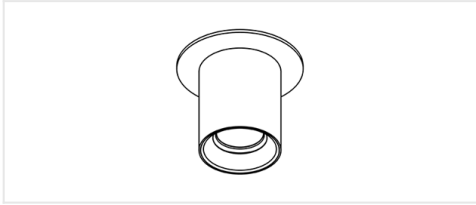

### **M: J-Box Cover**

Beauty ring to cover 4.0" j-box opening. Driver is remote

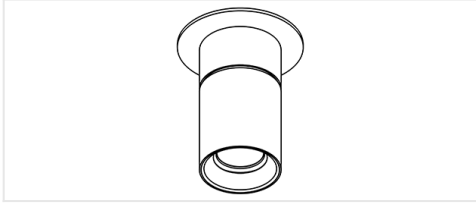

### **N: Canopy for On-Board Driver + J-Box Cover**

Canopy for on-board ELV or 0-10V driver. Beauty ring to cover 4.0" j-box opening