



Project	
Type	
Contact	

BONGO 4 (REMOTE)

1 Light Sources

4" | 2572 lm / per light source
Round | Fixed | Surface Mounted

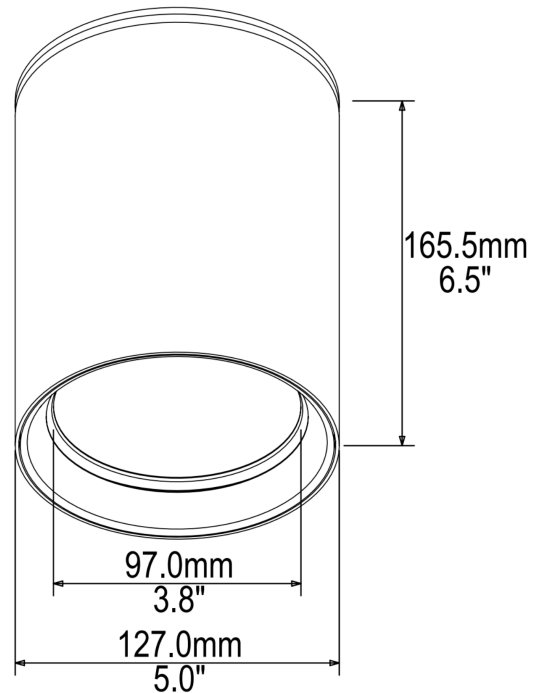

Performance Options	9W	13W	18W	26W
Source Lumens	1199 lm	1627 lm	2056 lm	2855 lm
Delivered Lumens	514 lm	1157 lm	1929 lm	2572 lm
Lumens / Watt	57 lm	89 lm	107 lm	99 lm
Current	250 mA	350 mA	500 mA	700 mA
CRI/CCT Multiplier	2700°K	3000°K	3500°K	4000°K
80 CRI	0.93	1.00	1.00	1.07
95 CRI	0.69	0.75	0.81	0.87



S4	BNG4R	—	—	—	—	—	—	—	—	—
Source	Model	Wattage	Kelvin	CRI	Beam	Lens	Color	Driver	Installation	I.P. Rating
S4	BNG4R:Bongo 4 (Remote)	09:09W 13:13W 18:18W 26:26W	27:2700k 30:3000k 35:3500k 40:4000k WD:Warm Dim 1800K to 3000K (Not possible with 18W) RW:RGBW TD:Tunable White 2700K to 6500K (Daylight) TH:Tunable White 1800K to 4000K (Hospitality)	A:80 B:95	6:60° 3:36° 2:24° 1:10°(WD, TH, TD, and RGBW not possible with 10°)	F:Frosted X:Hex Louver + Solite L:Cross Louver + Solite P:Prismatic S:Solite C:Clear	WS:Matte White BK:Matte Black WK:White Trim / Black Splay BP:Black Pearl SN:Satin Nickel BZ:Bronze CC:Custom Color	0:No Driver (Option when product is installed in Low Voltage - Class 2) N:Non-Dimmable N:Non-Dimmable () E:ELV Dimmable E:ELV Dimmable() Z:0-10V Dimmable to 1% Z:0-10V Dimmable to 1%() L:Lutron™ (Lutron EcoSystem / Canopy for on-board ELV or 0-10V driver) B:Bluetooth D:DALI X:DMX	RL:Retro-Fit for Lutron™ R0:Retro-Fit Enclosure	D:Dry IP 20

Optional Emergency Backup Battery can be found on Products/[Accessories](#)

Generated on 04-27-2024

Specifications

This specification Grade LED downlight offers a wide selection of LED modules options to address design requirements in the spaces it illuminates. Many additional custom options are available; please contact manufacturer for details.

LED source

Tool-free field-replaced LED module. Proprietary high performance aluminum die cast heatsink for maximum LED life.

Source

Computer-optimized reflector design. High reflected finish aluminum. Tool-free field-interchangeable reflectors and lens. 0-20°(O version), 0-40°(J version) vertical and 360° horizontal adjustment.

Body

Die-cast aluminum frame and body.

Trim

Die-cast aluminum CNC machine finished Minimal thickness. White can be field painted to match adjacent finishes.

Fixture retention

Two torsion springs hold the fixture tight to the ceiling accommodating ceiling thickness from 1/16" to 1". Special springs for thicker ceiling available on request.

Life

Rated for 50,000 hours at 70% lumen maintenance.

Label

ETL listed for US Canada. CE labeled. CCC label available on request.

Warranty

5 years limited warranty.

Wet location

(if option is available and selected on page 1) Sealed lens and integral silicon gasket behind the trim.

Dimming compatibility

Zaniboni fixture are compatible with all major dimming protocol in the industry. Please refer to zanibonilighting.com for general compatibility and wiring diagrams. Zaniboni recommends testing your unique dimming configuration as the exact full configuration (Dimmer, drivers, fixture quantities, voltage) may affect dimming performance.



N: Non-Dimmable

110-277V, 50/60Hz.

Economic solution for ON-OFF applications not requiring dimming.



E: ELV Dimmable

110-277V, 50/60Hz.

For ELV(Electronic Low Voltage) dimmers. Best for new construction application. Dims down to less than 10% light output(most cases). Consult dimming manufacturer for installation instructions. Must meet dimmer Minimum load Requirements.

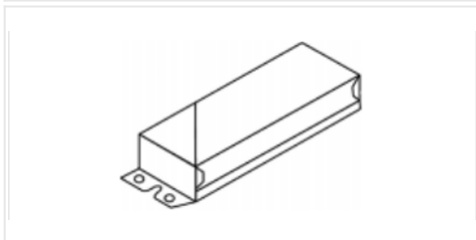

Z: 0-10V Dimmable

110-277, 50/60Hz.

Prevalent solution on commercial projects. Integrates into a variety of building management and day lighting controls. Dims down to less than 1% light output(most cases). Must meet dimmer Minimum Load Requirements. Consult dimming manufacturer for installation instructions.

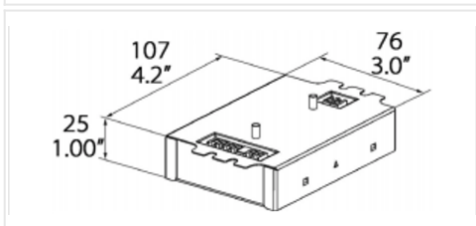

L: Lutron Hi-Lume A LDE

120-277V, 50/60Hz.

For LUTRON EcoSystem drivers only. Continuous dimming to 1%

Consult dimming manufacturer for installation instructions. Requires access from above on all fixtures with a cutout below 81mm.

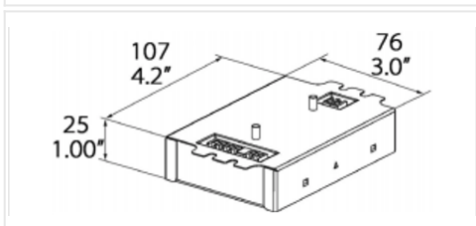

T: Lutron Hi-Lume A LTE

120V, 50/60Hz.

For 2-wire Forward Phase Controls. Continuous dimming to 1%

Consult dimming manufacturer for installation instructions. Requires access from above on all fixtures with a cutout below 81mm.

N&E: Non-Dimmable & ELV Drivers

Measurements	LWH in mm	LWH in inches
7W - 9W - 13W	85.5 - 38 - 27.7	3.36" - 1.49" - 1.09"
18W - 26W	89 - 41 - 31.5	3.5" - 1.62" - 1.24"
36W - 50W	89 - 41 - 31.5	3.5" - 1.62" - 1.24"

N&E: Non-Dimmable, ELV Drivers & 0-10V Dimmable

Measurements	LWH in mm	LWH in inches
7W - 9W - 13W	85.3 - 38 - 27.7	3.36" - 1.49" - 1.09"
18W - 26W	89 - 41 - 31.5	3.5" - 1.62" - 1.24"
36W - 50W	138 - 47 - 32	5.43" - 1.85" - 1.25"

Installation

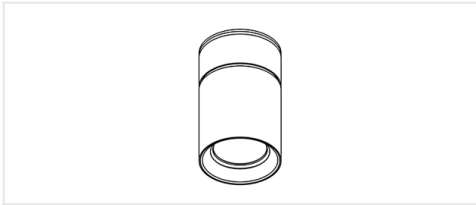

L: Canopy for On-Board Driver

Canopy for on-board ELV or 0-10V driver

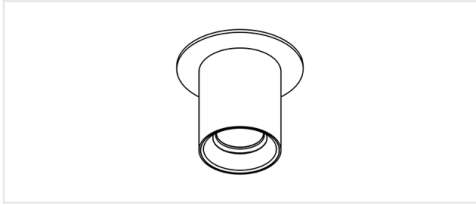

M: J-Box Cover

Beauty ring to cover 4.0" j-box opening. Driver is remote

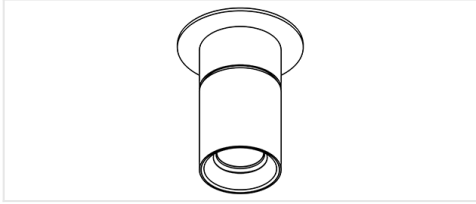

N: Canopy for On-Board Driver + J-Box Cover

Canopy for on-board ELV or 0-10V driver. Beauty ring to cover 4.0" j-box opening