



BONGO 6 (REMOTE)

1 Light Sources

6" | 5000 lm / per light source
Round | Fixed | Surface Mounted

Performance Options	18W	26W	36W	50W
Source Lumens	2294 lm	3059 lm	3642 lm	5750 lm
Delivered Lumens	1965 lm	3037 lm	3574 lm	5000 lm
Lumens / Watt	109 lm	117 lm	99 lm	100 lm
Current	500 mA	700 mA	900 mA	1400 mA
CRI/CCT Multiplier	2700°K	3000°K	3500°K	4000°K
80 CRI	0.93	1.00	1.00	1.07
95 CRI	0.69	0.75	0.81	0.87

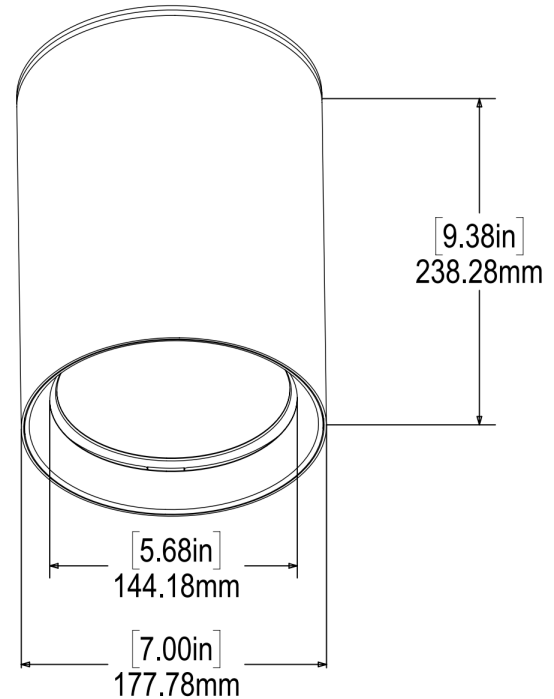

S6	BNG6R	—	—	—	—	—	—	—	—	—
Source	Model	Wattage	Kelvin	CRI	Beam	Lens	Color	Driver	Installation	I.P. Rating
S6	BNG6R:Bongo 6 (Remote)	18:18W 26:26W 36:36W 50:50W	27:2700k 30:3000k 35:3500k 40:4000k WD:Warm Dim 1800K to 3000K (Not possible with 18W) RW:RGBW TD:Tunable White 2700K to 6500K (Daylight) TH:Tunable White 1800K to 4000K (Hospitality)	A:80 B:95	6:60° 3:36° 2:24°	F:Frosted X:Hex Louver + Solite L:Cross Louver + Solite P:Prismatic S:Solite C:Clear	WS:Matte White BK:Matte Black WK:White Trim / Black Splay BP:Black Pearl SN:Satin Nickel BZ:Bronze CC:Custom Color	0:No Driver Z:0-10V Dimmable to 1% Z:0-10V Dimmable to 1%(-) E:ELV Dimmable E:ELV Dimmable (-) L:Lutron™ (Lutron EcoSystem) N:Non-Dimmable N:Non-Dimmable (-) U:Lutron™ (Phase Dimming) +EM Backup+ Remote Only D:DALI X:DMX	R0:Retro-Fit Enclosure RL:Retro-Fit for Lutron™	D:Dry IP 20

Optional Emergency Backup Battery can be found on Products/[Accessories](#)

Generated on 04-26-2024

Specifications

This specification Grade LED downlight offers a wide selection of LED modules options to address design requirements in the spaces it illuminates. Many additional custom options are available; please contact manufacturer for details.

LED source

Tool-free field-replaced LED module. Proprietary high performance aluminum die cast heatsink for maximum LED life.

Source

Computer-optimized reflector design. High reflected finish aluminum. Tool-free field-interchangeable reflectors and lens. 0-20°(O version), 0-40°(J version) vertical and 360° horizontal adjustment.

Body

Die-cast aluminum frame and body.

Trim

Die-cast aluminum CNC machine finished Minimal thickness. White can be field painted to match adjacent finishes.

Fixture retention

Two torsion springs hold the fixture tight to the ceiling accommodating ceiling thickness from 1/16" to 1". Special springs for thicker ceiling available on request.

Life

Rated for 50,000 hours at 70% lumen maintenance.

Label

ETL listed for US Canada. CE labeled. CCC label available on request.

Warranty

5 years limited warranty.

Wet location

(if option is available and selected on page 1) Sealed lens and integral silicon gasket behind the trim.

Dimming compatibility

Zaniboni fixture are compatible with all major dimming protocol in the industry. Please refer to zanibonilighting.com for general compatibility and wiring diagrams. Zaniboni recommends testing your unique dimming configuration as the exact full configuration (Dimmer, drivers, fixture quantities, voltage) may affect dimming performance.



N: Non-Dimmable

110-277V, 50/60Hz.

Economic solution for ON-OFF applications not requiring dimming.



E: ELV Dimmable

110-277V, 50/60Hz.

For ELV(Electronic Low Voltage) dimmers. Best for new construction application. Dims down to less than 10% light output(most cases). Consult dimming manufacturer for installation instructions. Must meet dimmer Minimum load Requirements.

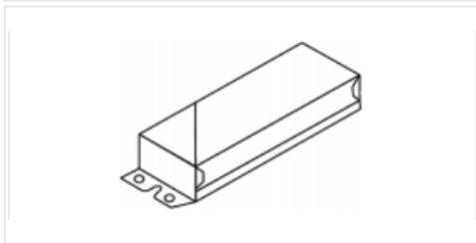

Z: 0-10V Dimmable

110-277, 50/60Hz.

Prevalent solution on commercial projects. Integrates into a variety of building management and day lighting controls. Dims down to less than 1% light output(most cases). Must meet dimmer Minimum Load Requirements. Consult dimming manufacturer for installation instructions.

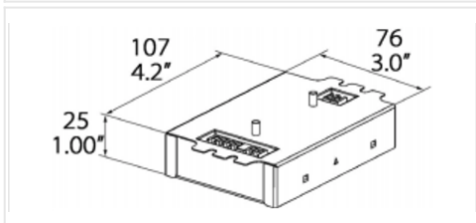

L: Lutron Hi-Lume A LDE

120-277V, 50/60Hz.

For LUTRON EcoSystem drivers only. Continuous dimming to 1%

Consult dimming manufacturer for installation instructions. Requires access from above on all fixtures with a cutout below 81mm.

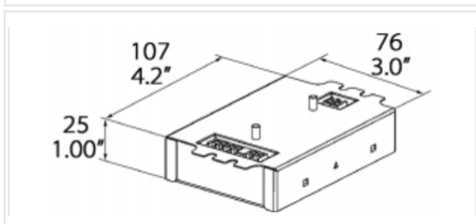

T: Lutron Hi-Lume A LTE

120V, 50/60Hz.

For 2-wire Forward Phase Controls. Continuous dimming to 1%

Consult dimming manufacturer for installation instructions. Requires access from above on all fixtures with a cutout below 81mm.

N&E: Non-Dimmable & ELV Drivers

Measurements	LWH in mm	LWH in inches
7W - 9W - 13W	85.5 - 38 - 27.7	3.36" - 1.49" - 1.09"
18W - 26W	89 - 41 - 31.5	3.5" - 1.62" - 1.24"
36W - 50W	89 - 41 - 31.5	3.5" - 1.62" - 1.24"

N&E: Non-Dimmable, ELV Drivers & 0-10V Dimmable

Measurements	LWH in mm	LWH in inches
7W - 9W - 13W	85.3 - 38 - 27.7	3.36" - 1.49" - 1.09"
18W - 26W	89 - 41 - 31.5	3.5" - 1.62" - 1.24"
36W - 50W	138 - 47 - 32	5.43" - 1.85" - 1.25"

Installation

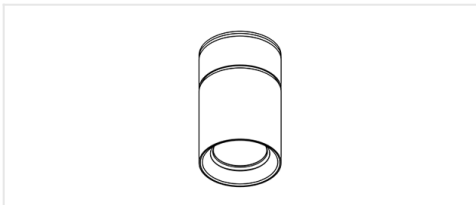

L: Canopy for On-Board Driver

Canopy for on-board ELV or 0-10V driver

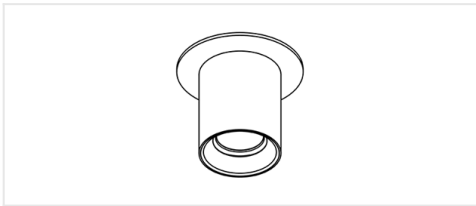

M: J-Box Cover

Beauty ring to cover 4.0" j-box opening. Driver is remote

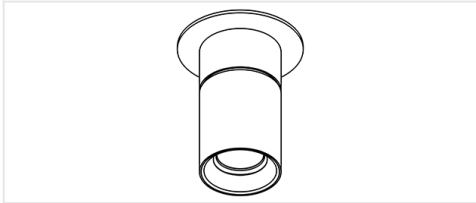

N: Canopy for On-Board Driver + J-Box Cover

Canopy for on-board ELV or 0-10V driver. Beauty ring to cover 4.0" j-box opening