



BONGO 2 W

1 Light Sources

2" | 1441 lm / per light source
Round | Fixed | Surface Mounted, Wall Washer

Performance Options	9W	13W	18W		
Source Lumens	1188 lm	1563 lm	2032 lm		
Delivered Lumens	818 lm	1096 lm	1441 lm		
Lumens / Watt	91 lm	84 lm	80 lm		
Current	250 mA	350 mA	500 mA		
CRI/CCT Multiplier	2700°K	3000°K	3500°K	4000°K	Warm Dim
80 CRI	0.93	1.00	1.00	1.07	N/A
95 CRI	0.69	0.75	0.81	0.87	0.72

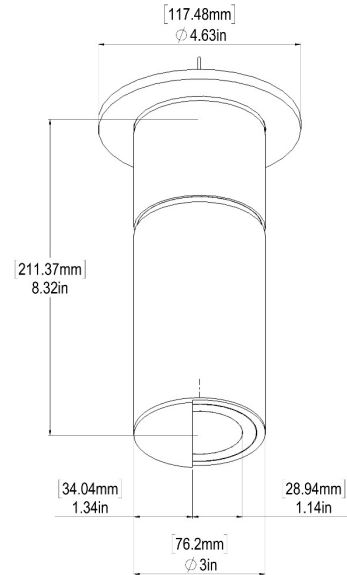

S2	BON2W	—	—	—	—	—	—	—	—	—
Source	Model	Wattage	Kelvin	CRI	Beam	Lens	Color	Driver	Installation	I.P. Rating
S2	BON2W:Bongo 2 W	09:09W 13:13W 18:18W	27:2700k 30:3000k 35:3500k 40:4000k	C:90 D:VeroLux (CRI 97+ Contact your sales representative for ordering information. Check for ESD. 10 weeks lead if not in stock.)	W:Wallwasher	W:Wallwasher	WS:Matte White BK:Matte Black WK:White Trim / Black Splay BP:Black Pearl SN:Satin Nickel BZ:Bronze CC:Custom Color	N:Non-Dimmable E:ELV Dimmable Z:0-10V Dimmable to 1% B:BubblyNet (Remote-Mount Only Speak with Zaniboni Rep) D:DALI (Remote-Mount Only Speak with Zaniboni Rep) X:Eldo DMX (Remote-Mount Only Speak with Zaniboni Rep) V:Low Voltage CC2CV (Price does not include power supply)	NI:Canopy for On-Board Driver + J-Box Cover (Canopy for on-board ELV or 0-10V driver. Beauty ring to cover 4.0" j-box opening) R0:Retro-Fit Enclosure RL:Retro-Fit for Lutron™ LI:Canopy for Integral Driver	D:Dry IP 20

Optional Emergency Backup Battery can be found on Products/[Accessories](#)

Generated on 05-15-2026

Specifications

This specification Grade LED downlight offers a wide selection of LED modules options to address design requirements in the spaces it illuminates. Many additional custom options are available; please contact manufacturer for details.

LED source

Tool-free field-replaced LED module. Proprietary high performance aluminum die cast heatsink for maximum LED life.

Source

Computer-optimized reflector design. High reflected finish aluminum. Tool-free field-interchangeable reflectors and lens. 0-20°(O version), 0-40°(J version) vertical and 360° horizontal adjustment.

Body

Die-cast aluminum frame and body.

Trim

Die-cast aluminum CNC machine finished Minimal thickness. White can be field painted to match adjacent finishes.

Fixture retention

Two torsion springs hold the fixture tight to the ceiling accommodating ceiling thickness from 1/16" to 1". Special springs for thicker ceiling available on request.

Life

Rated for 50,000 hours at 70% lumen maintenance.

Label

ETL listed for US Canada. CE labeled. CCC label available on request.

Warranty

5 years limited warranty.

Wet location

(if option is available and selected on page 1) Sealed lens and integral silicon gasket behind the trim.

Dimming compatibility

Zaniboni fixture are compatible with all major dimming protocol in the industry. Please refer to zanibonilighting.com for general compatibility and wiring diagrams. Zaniboni recommends testing your unique dimming configuration as the exact full configuration (Dimmer, drivers, fixture quantities, voltage) may affect dimming performance.



N: Non-Dimmable

110-277V, 50/60Hz.

Economic solution for ON-OFF applications not requiring dimming.



E: ELV Dimmable

110-277V, 50/60Hz.

For ELV(Electronic Low Voltage) dimmers. Best for new construction application. Dims down to less than 10% light output(most cases). Consult dimming manufacturer for installation instructions. Must meet dimmer Minimum load Requirements.

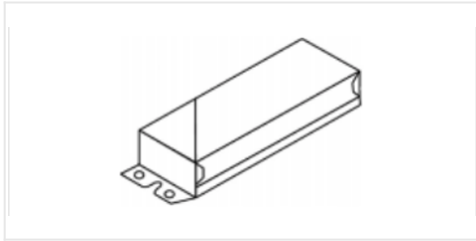

Z: 0-10V Dimmable

110-277, 50/60Hz.

Prevalent solution on commercial projects. Integrates into a variety of building management and day lighting controls. Dims down to less than 1% light output(most cases). Must meet dimmer Minimum Load Requirements. Consult dimming manufacturer for installation instructions.

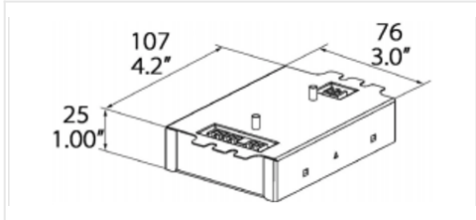

L: Lutron Hi-Lume A LDE

120-277V, 50/60Hz.

For LUTRON EcoSystem drivers only. Continuous dimming to 1%

Consult dimming manufacturer for installation instructions. Requires access from above on all fixtures with a cutout below 81mm.

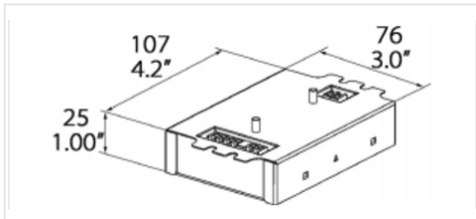

T: Lutron Hi-Lume A LTE

120V, 50/60Hz.

For 2-wire Forward Phase Controls. Continuous dimming to 1%

Consult dimming manufacturer for installation instructions. Requires access from above on all fixtures with a cutout below 81mm.

N&E: Non-Dimmable & ELV Drivers

Measurements	LWH in mm	LWH in inches
7W - 9W - 13W	85.5 - 38 - 27.7	3.36" - 1.49" - 1.09"
18W - 26W	89 - 41 - 31.5	3.5" - 1.62" - 1.24"
36W - 50W	89 - 41 - 31.5	3.5" - 1.62" - 1.24"

N&E: Non-Dimmable, ELV Drivers & 0-10V Dimmable

Measurements	LWH in mm	LWH in inches
7W - 9W - 13W	85.3 - 38 - 27.7	3.36" - 1.49" - 1.09"
18W - 26W	89 - 41 - 31.5	3.5" - 1.62" - 1.24"
36W - 50W	138 - 47 - 32	5.43" - 1.85" - 1.25"

Installation

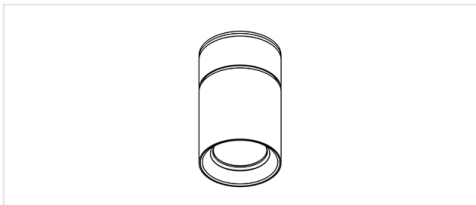

L: Canopy for On-Board Driver

Canopy for on-board ELV or 0-10V driver

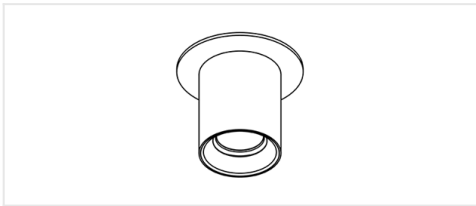

M: J-Box Cover

Beauty ring to cover 4.0" j-box opening. Driver is remote

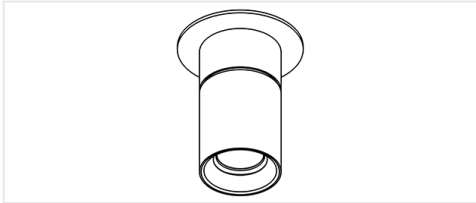

N: Canopy for On-Board Driver + J-Box Cover

Canopy for on-board ELV or 0-10V driver. Beauty ring to cover 4.0" j-box opening