

Trimless Mount Mini-Track

- T Series Dry Wall

Project:
Type:
Contact:

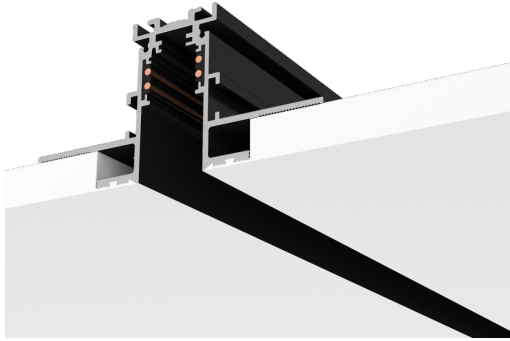

K M2T

MODEL	Track Length	Color
M2T: Mini-Track Trimless T	04 : 4 FT 08 : 8 FT	W00 : White B00 : Black

Notes:

Drivers are designed with universal input voltage compatibility, accommodating a range from 120V to 277V.

DIMENSIONS / DRAWINGS

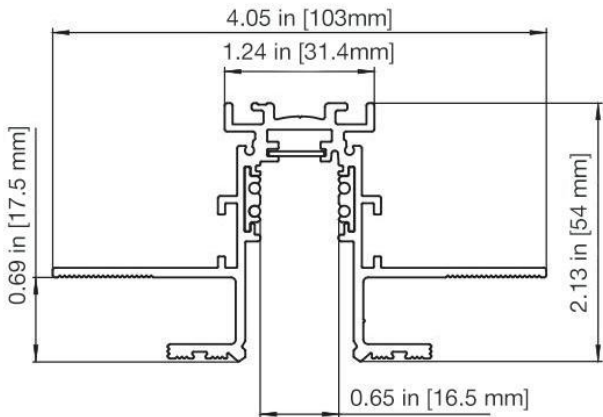

MAX LOAD

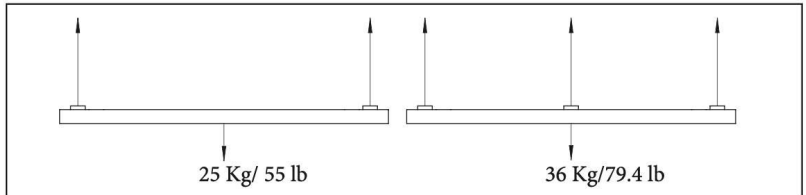



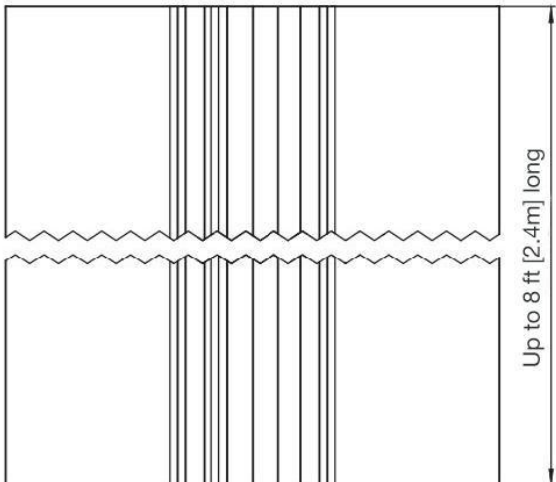





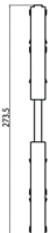

Max. Distance from 2 cables of the suspension kit cords must be:
 2.95 ft (900mm) for 25Kg/55lb Max. load.
 1.47 ft (450mm) for 36Kg/79.5lb Max load.

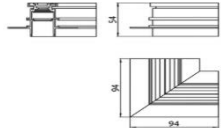

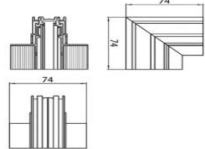
TRIMLESS MOUNT MINI-TRACK ACCESSORIES

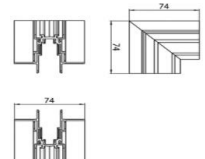
T SERIES

CODE	NAME	DESCRIPTION		
K-MB0-MN-BREIO W-White	Reinforcing Bracket	Mini-Track Reinforcing Bracket For Jointing Connector		
K-MED-00-B0000 W-White	End Feed	End Cap For Pendant Track And Trimless Mini-Track With Locking Screws		
K-MED-00-B000H W-White	End Cap With Central Hole	End Cap For Pendant Track And Trimless D Mini-Track With Locking Screws With Central Hole And Gasket For Cable		
K-MF0-00-BEND0 W-White	End Feed	Mini-Track Short End Feed		
K-MF0-00-BMIDE W-White	End Feed	Mini-Track Short Jointing Connector with Electrical Connection.		
K-MF0-00-BMIDM W-White	Non-conductive Joiner	Mini-Track Short Mechanical Jointing Connector		
K-MF0-00-BL000 W-White	L Conductive Joiner	Mini-Track L Conductive Joiner		

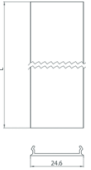
CODE	NAME	DESCRIPTION		
K-MF0-00-BCORO W-White	Corner Conductive Joiner	Mini-Track And Adjustable Corner Feed		
K-MJH-00-BCIWW	Corner Joint	Corner Joint For Surface/ Pendant/Recessed Trimless Mini-Track		
K-MJH-00-BCECW	Corner Joint	Corner Joint For Surface/ Pendant/Recessed Trimless Mini-Track		
K-MJH-00-BCICW	Corner Joint	Mini-Track Corner Joint For Surface/ Pendant/Recessed Trimless Mini-Track Short End Feed		
K-MC0-04-BSTAE W-White	Cover Strip	Mini-Track Cover (Aesthetic) - 4FT		
K-MC0-08-BSTAE W-White	Cover Strip	Mini-Track Cover (Aesthetic) - 8FT		

Product Overview

Type: Trimless Mini-Track T

Circuit(s)/Amps: 2 circuits: 2x +/- 15A/0-60V dc or 1 circuit + Data Bus: +/- 10A/0-60V + D+/D-

Voltage: 24V/48V

Weight: 1.01 lb. [459g] / ft / 1506.2g/kg

Available Colors: Black RAL 9005 embossed / White RAL 9016 embossed

Driver: DALI 1% dim, 0-10V 1% dim, Forward/Reverse Phase Cut dim

Compatible Track Lighting

Linear: 90+ CRI, 3000K



L1-RIGAJO

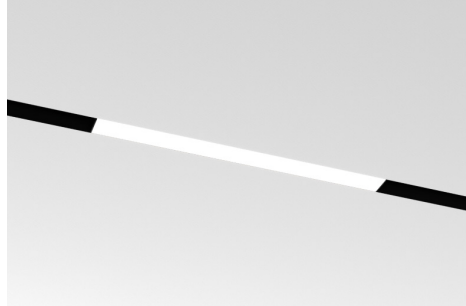

L1-RIGMO

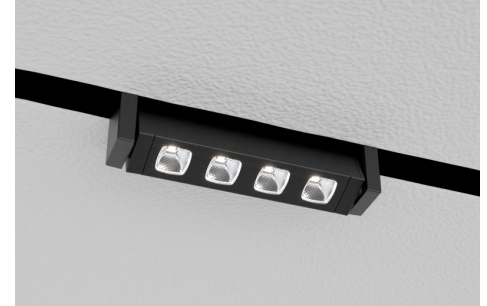

L1-RIGAJ

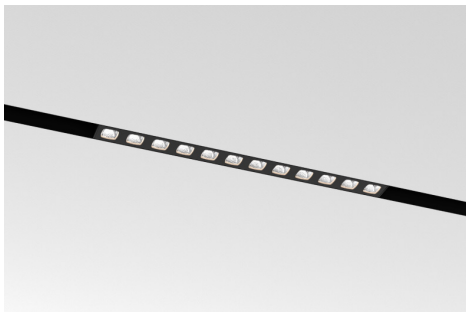

L1-RIGMU

WEIGHT	RIGAJO	RIGMO	RIGAJ	RIGMU
12 in	0.81 in	0.42	0.9	0.48
24 in	1.34 in	0.7	1.5	0.86
34 in	1.94 in	1.0	2.2	1.3
45 in	NA	1.3	NA	NA
56 in	NA	1.6	NA	NA

VOLTAGE	RIGAJO	RIGMO	RIGAJ	RIGMU	LUMEN/FT	RIGAJO	RIGMO	RIGAJ	RIGMU
	48V	48V	24V	24V		495	495	510.5	510.5

ADJUSTABLE	RIGAJO	RIGMO	RIGAJ	RIGMU	LUMEN/FT	RIGAJO	RIGMO	RIGAJ	RIGMU
	Yes	No	Yes	No		6W	6W	5.4 W	5.4W

Compatible Track Lighting

Pendant: 80+/90+ CRI, 2700K/3000K/3500K/4000K/Amber



PO-TI

Voltage: 24V/48V
Lumens: 291lm(3W), 493lm(7W)
Length: 12in/18in/24in/36in/48in
Weight(12in): 0.537lb.

Track Heads: 80+/90+ CRI, 2700K/3000K/3500K/4000K/Warm Dim



K0-GEM20



K1-GEML2



K0-GEM4R



K1-GEML4



K1-GEL6R

Voltage: 24V

WEIGHT(LB)	GEM20	GEML2	GEM4R	GEML4	GEL6R
	0.319	0.392	0.352	0.515	0.585

APERATURE(IN)	GEM20	GEML2	GEM4R	GEML4	GEL6R
	0.7	1	0.7	1	1

END FEED: Wiring Diagram

- **0-10V, Dali, ONE CIRCUIT**

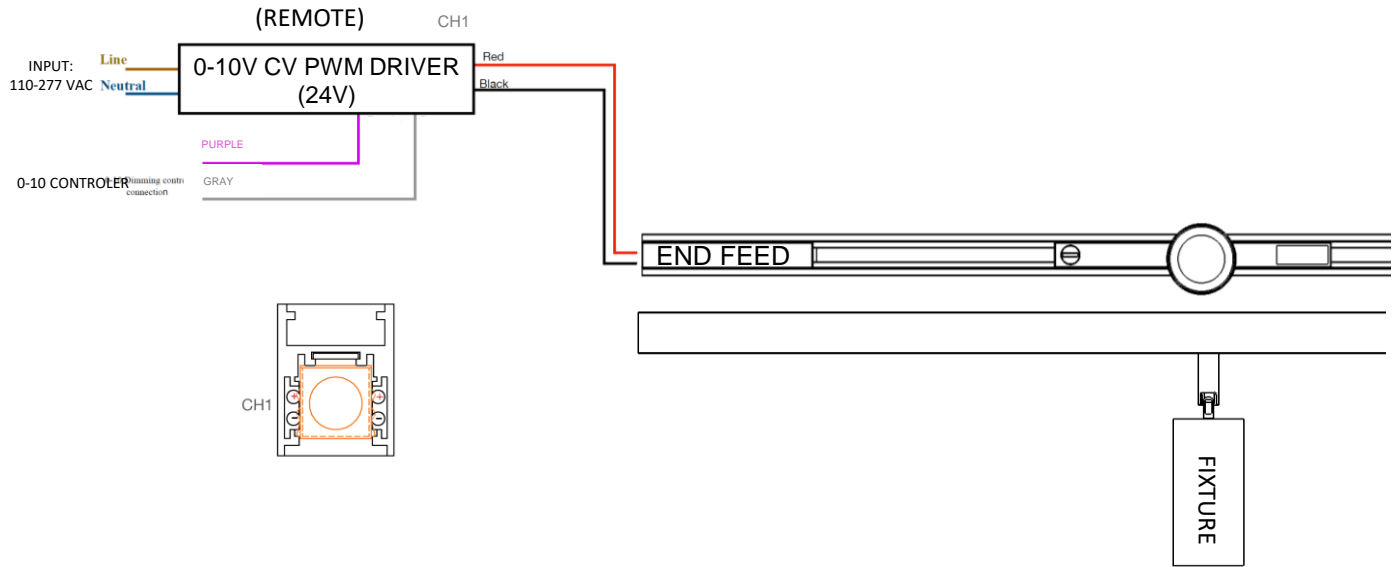

- **0-10V, Dali, TWO CIRCUIT**

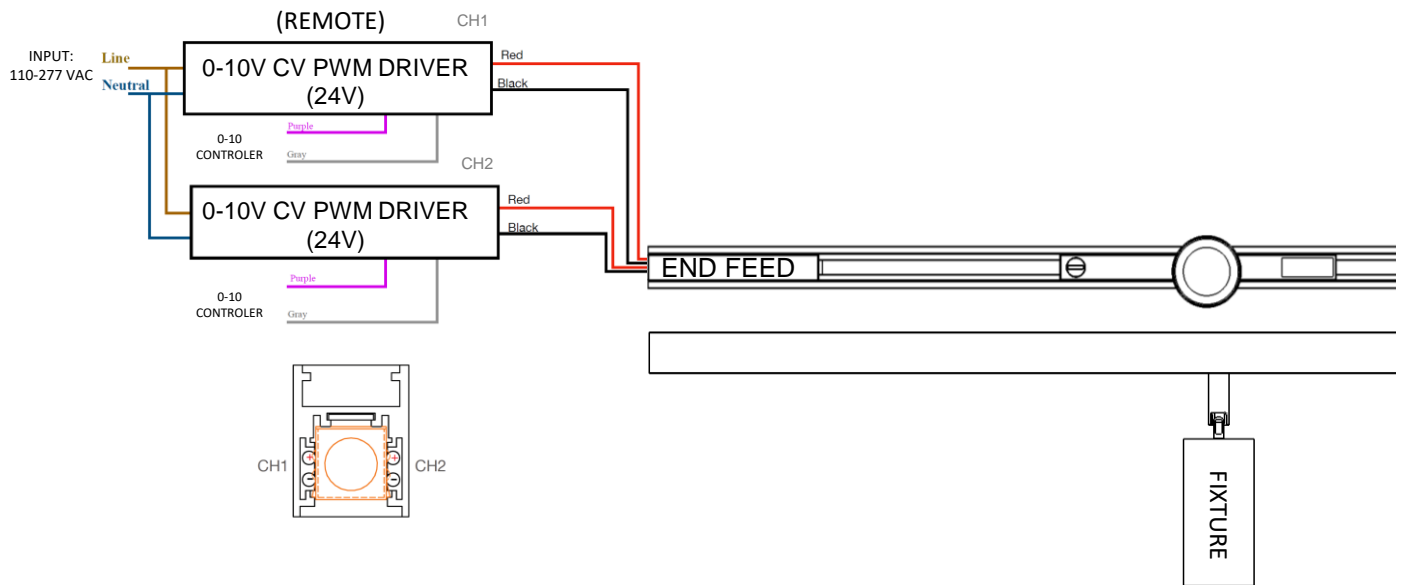

END FEED: Wiring Diagram



CHANNEL 1 MINI TRACK END FEED WIRING

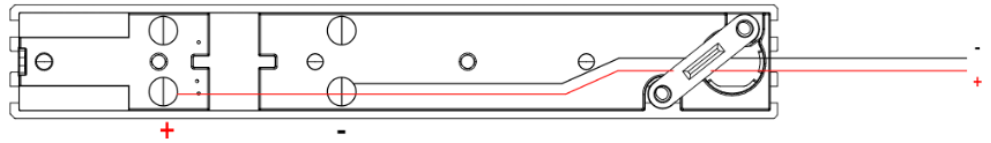

CHANNEL 2 MINI TRACK END FEED WIRING

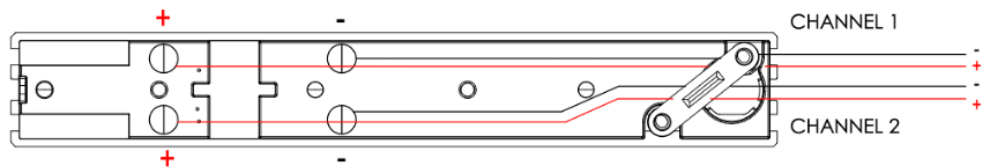

END FEED: Installation

