

LINE TRACK 2 CIRCUIT | 277V AC

Project:
Type:
Contact:

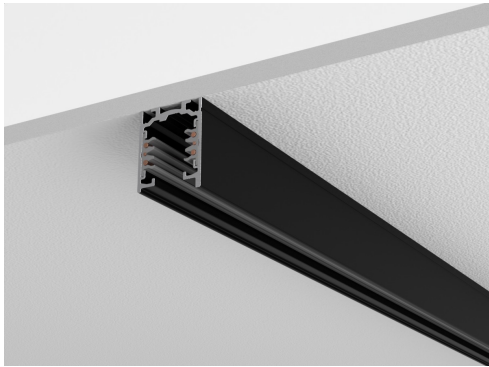

- Track
- External extruded body in aluminum.
- Copper conductors.
- Surface & Pendant Mounting
- Rated Current: 20 Amp



K L2S

MODEL	Track Length	Color
L2S: LINE TRACK 2 CIRCUIT 277V AC	04 : 4 FT 08 : 8 FT	B277 : Black W277 : White

Line Drawings

Surface/Pendant version

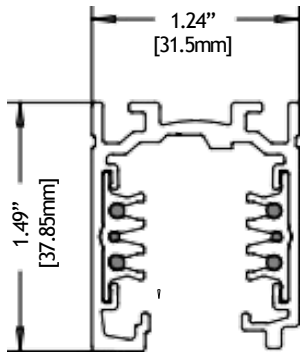

Load scheme

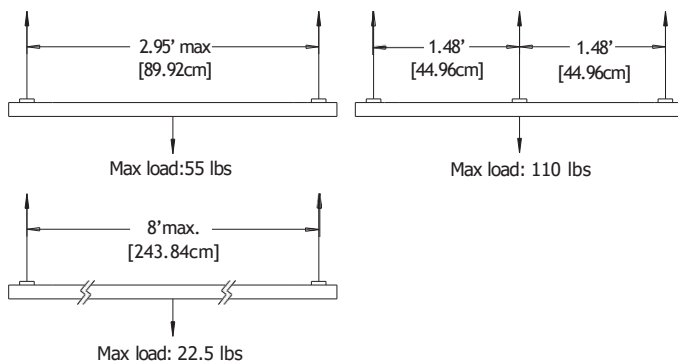

LINE TRACK END FEED: Wiring Diagram



LINE TRACK END FEED, DMX CONTROLLER

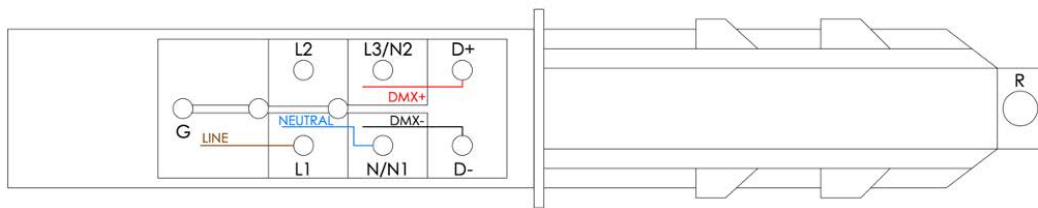

LINE TRACK END FEED, 0-10V CONTROL

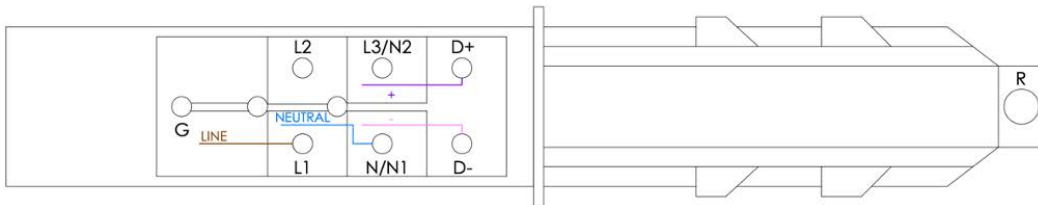

SURFACE/PENDANT LINE TRACK

2 CIRCUIT TRACK - 277v AC

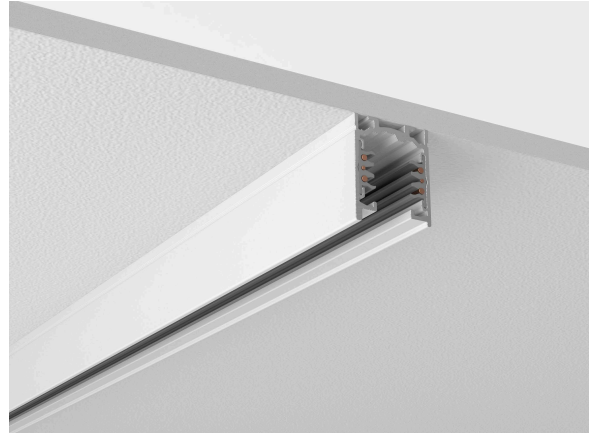

CODE	NAME	DESCRIPTION
K-LES-00-B0000	End Cap	End Cap For Surface S Mounted Line Voltage Track With Locking Screws

W - White

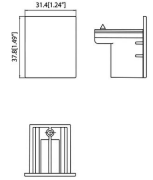

K-LK0-04-00100	Suspension Kit	Line Voltage Track Suspension Kit Screw Gripper + Steel Cable 1.5mm Diameter, 4.9ft (1.5m) Long With Clamp With Automatic Gripper
-----------------------	----------------	--

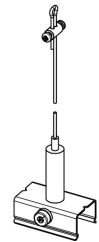



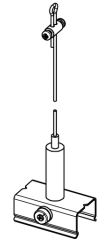





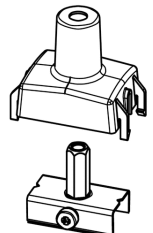



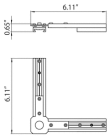

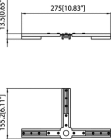
K-LK0-09-00100	Suspension Kit	Line Voltage Track Suspension Kit, Steel Cable 1.5mm Diameter, 1.5mm Diameter, 9.8ft (3m) Long
-----------------------	----------------	--

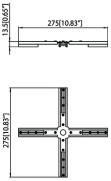

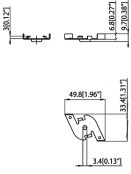

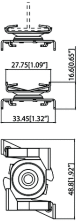

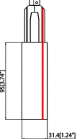
K-L00-00-BC000	Pendant Clip	Pendant Clip For Line Voltage Track
-----------------------	--------------	-------------------------------------

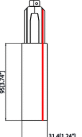
W - White

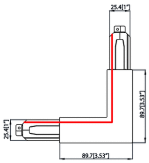

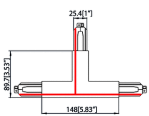
CODE	NAME	DESCRIPTION		
K-LB0-00-REI0L	L Joiner	"L" Joiner Reinforcing Bracket For Line Voltage Track		
K-LB0-00-REI0T	T Joiner	"T" Joiner Reinforcing Bracket For Line Voltage Track		
K-LB0-00-REI0X	X Joiner	"X" Joiner Reinforcing Bracket For Line Voltage Track		
K-LB0-00-BCBK0 W - White	Clamp Bracket	Painted Clamp Bracket For Line Voltage Track		
K-LB0-00-BCBK0G W - White	Clamp Bracket	Grid Ceiling Painted Clamp Bracket For Line Voltage Track		
K-LF0-02-BENDL W - White	End Feed	2 Circuit Line Voltage Track End Feed, Polarity Right Earth Left		
K-LF0-02-BENDR W - White	End Feed	2 Circuit Line Voltage Track End Feed, Polarity Left Earth Right		

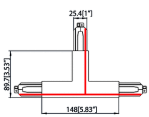
CODE	NAME	DESCRIPTION		
K-LF0-02-BMIDE W - White	Mid Conductive Joiner	2 Circuit Line Voltage Track Mid Conductive Joiner		
K-LF0-02-BLEXT W - White	L Conductive Joiner	2 Circuit Line Voltage Track "L" Feed, Polarity Internal Earth External		
K-LF0-02-BLINT W - White	L Conductive Joiner	2 Circuit Line Voltage Track "L" Feed, Polarity External Earth Internal		
K-LF0-02-BTINR W - White	T Conductive Joiner	2 Circuit Line Voltage Track "T" Feed, Polarity External Left, Earth Internal Right		
K-LF0-02-BTINL W - White	T Conductive Joiner	2 Circuit Line Voltage Track "T" Feed, Polarity External Right, Earth Internal Left		
K-LF0-02-BTEXR W - White	T Conductive Joiner	2 Circuit Line Voltage Track "T" Feed, Polarity Internal Left, Earth External Right		
K-LF0-02-BTEXL W - White	T Conductive Joiner	2 Circuit Line Voltage Track "T" Feed, Polarity Internal Right, Earth External Left		

CODE	NAME	DESCRIPTION
K-LF0-02-BXFD0 W - White	X Conductive Joiner	2 Circuit Line Voltage Track "X" Feed

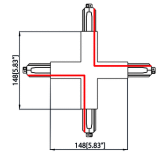

K-L00-WS-ADAPD WS - White BK Black	Adapter	2 Circuit Track Adapter
---	---------	-------------------------

